

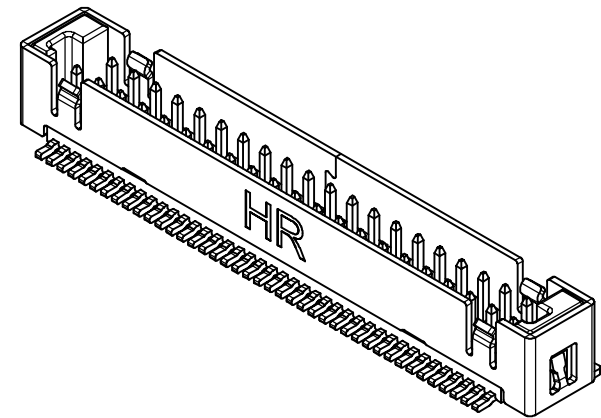

SUGGESTED PCB LAYOUT
(COMPONENT SIDE)

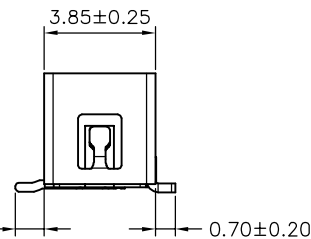
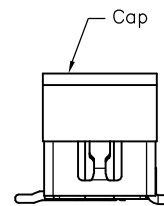
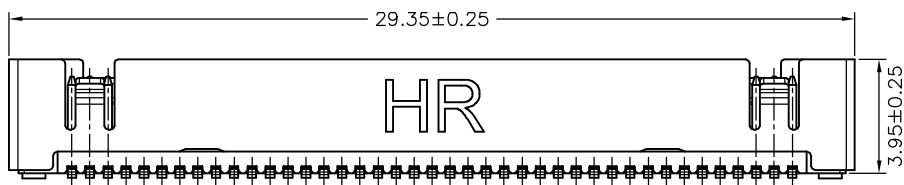
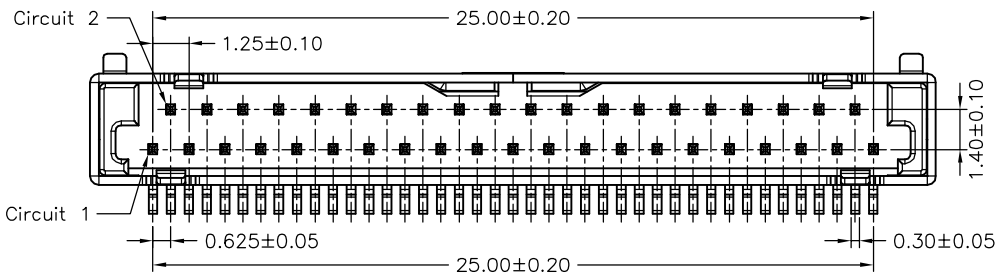

SPECIFICATIONS

Current Rating: 1A AC,DC
 Voltage Rating: 200V AC,DC
 Temperature Range: -25°C ~ +85°C
 Contact Resistance: 40mΩ Max.
 Insulation Resistance: 100MΩ Min.
 Withstanding Voltage: 500V AC/minute
 Pin Material: Phosphor Bronze/Gold-plated 3u"
 Shell: Phosphor Bronze/Tin-plated
 Cap: Nylon 6T,UL94V-0,Natural(Black)
 Material: Nylon 6T,UL94V-0
 Color: Natural(Black)

				JOINT TECH ELECTRONIC IND. CO., LTD. JOY DAY INDUSTRIAL CO., LTD.		
		UNIT	SCALE	SHEET	TITLE:	
		mm		1 of 2	P/N: A1256WVB-S-41P, 1.25mm PITCH 180° DUAL ROW WAFER- SMT TYPE, SHELL, W/O BOSS	
		DRAWN BY	APPROVED BY		DRAW NO.: A1256WVB-S-41P	
		歐陽小強 2007.09.12	謝瑞清 2007.09.12			
		GENERAL TOLERANCE				REV. A1
A1	REVISE	2007.11.06	X.X±0.25	ANGLE±		
A0	NEW RELEASE	2007.09.12	X.XX±0.15			
REV.	DESCRIPTION	DATE	X.XXX±0.05			

